

Bart's Electrical Service
Fuel gard
(213) 595-5075

Tank For Stationary Use Only

Capacity 4,000 Gallons Heads Primary 1/4" Paint Ext. Red Primer
 Design Singlewall Shell Primary 1/4" Paint Int. _____
 Code UL 142 Heads Secondary _____ Weight Empty 5,000 lbs.
 Test Pres. 5 PSI Shell Secondary _____ Rev.# _____ Date: _____

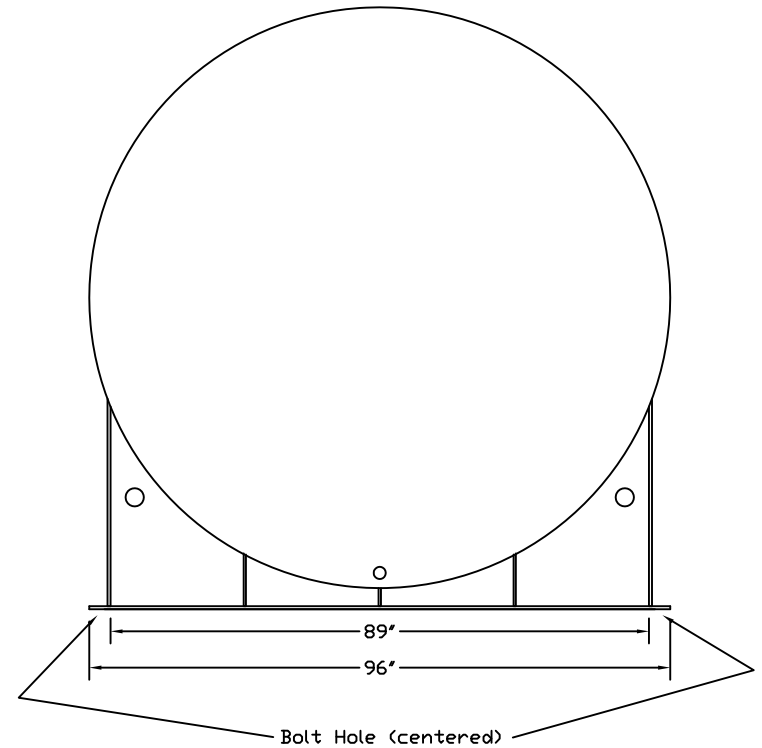
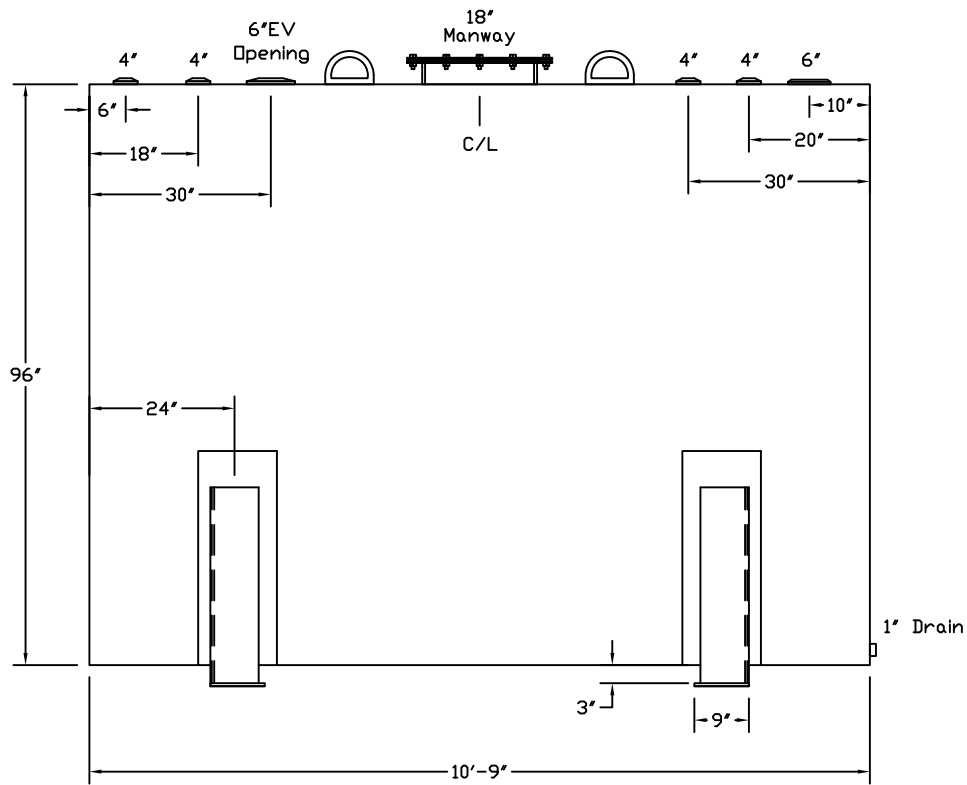

Customer: _____ Drg. Date: _____

Quoted Lead Times Begin Upon Receipt of signed Approved Drawing, Which Must be Returned Before Production Can Begin.

Drawing Approved By: _____